

Side View Front View

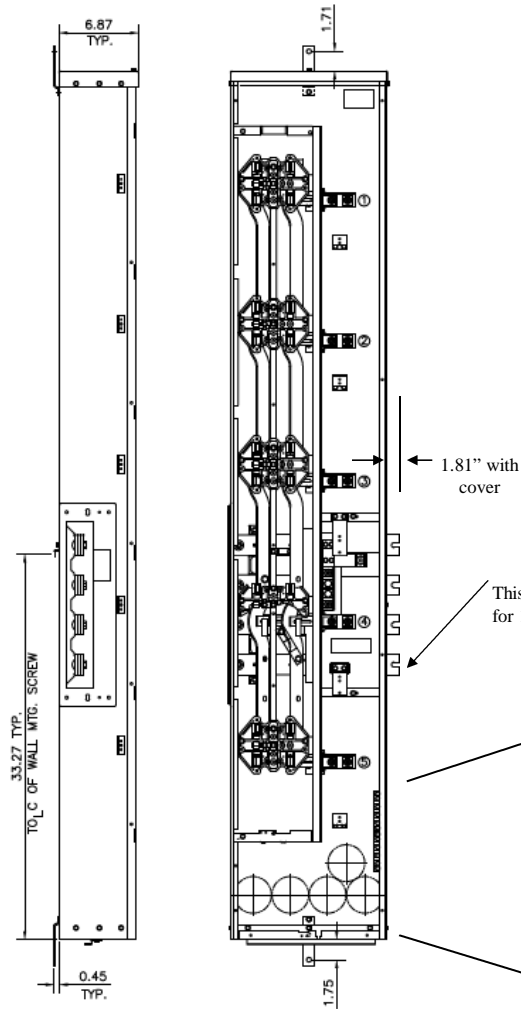

Front Layout View

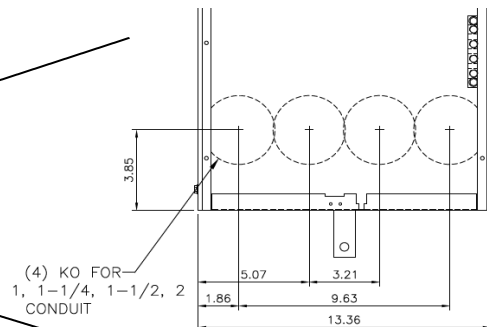
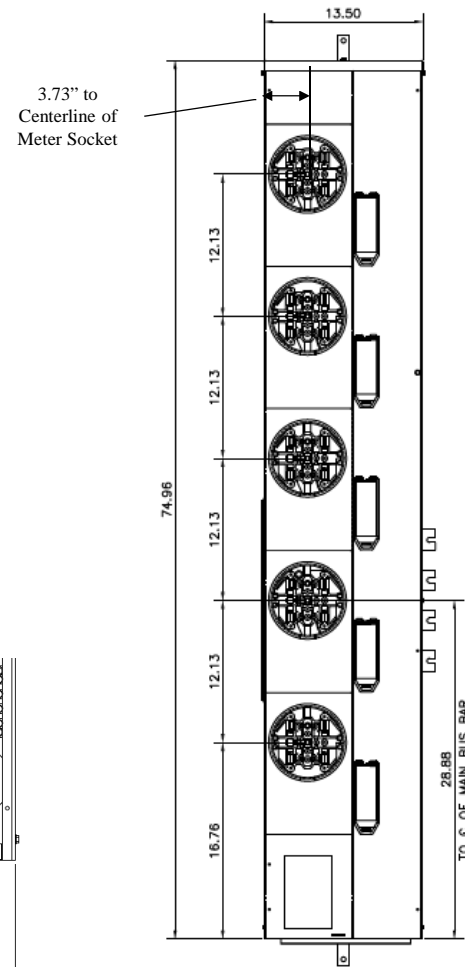

(6) CONCENTRIC K.O.'S
1", 1-1/4", 1-1/2", 2"

Bottom View

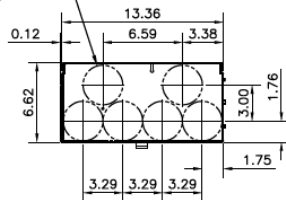

Top view has blank end walls (no knockouts)



imagination at work

METER MOD III – 1PH 800A HORIZONTAL BUSSING
(5) 200A RING SOCKETS – N3R ENCLOSURE

REF NO	CAT NO	DWG DATE	REV #
96-6084	TMP8520R	1/8/2015	01