

Front View

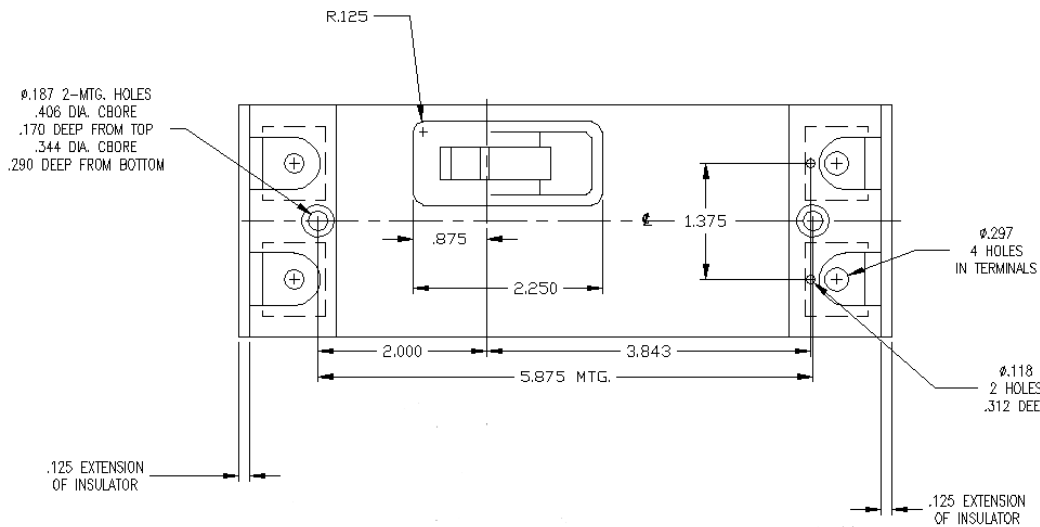

Top View

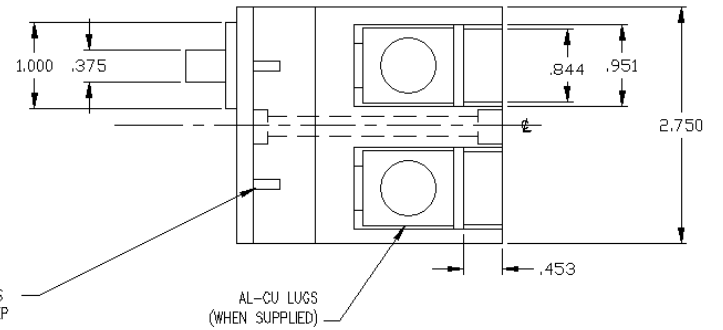

Side View

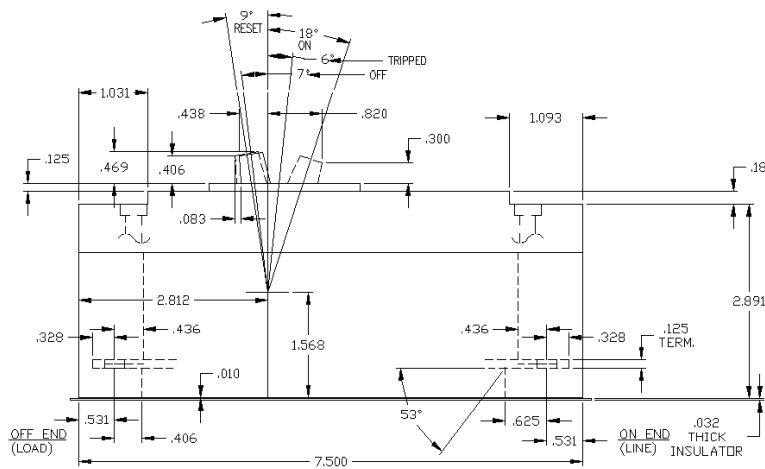

Breaker Amps	Load Side Wire Range Size
70A	"On" End - (1) #6 - 4/0 (AL or CU) "Off" End - (1) #6 - 1/0 (AL or CU)
80A	"On" End - (1) #6 - 4/0 (AL or CU) "Off" End - (1) #6 - 1/0 (AL or CU)
90A	"On" End - (1) #6 - 4/0 (AL or CU) "Off" End - (1) #6 - 1/0 (AL or CU)



imagination at work

90A 2PH TMQD BREAKER 100K @ 208Y/120

REF NO	CAT NO	DWG DATE	REV #
96-2227	TMQD22090	03/20/2015	01