

Top View

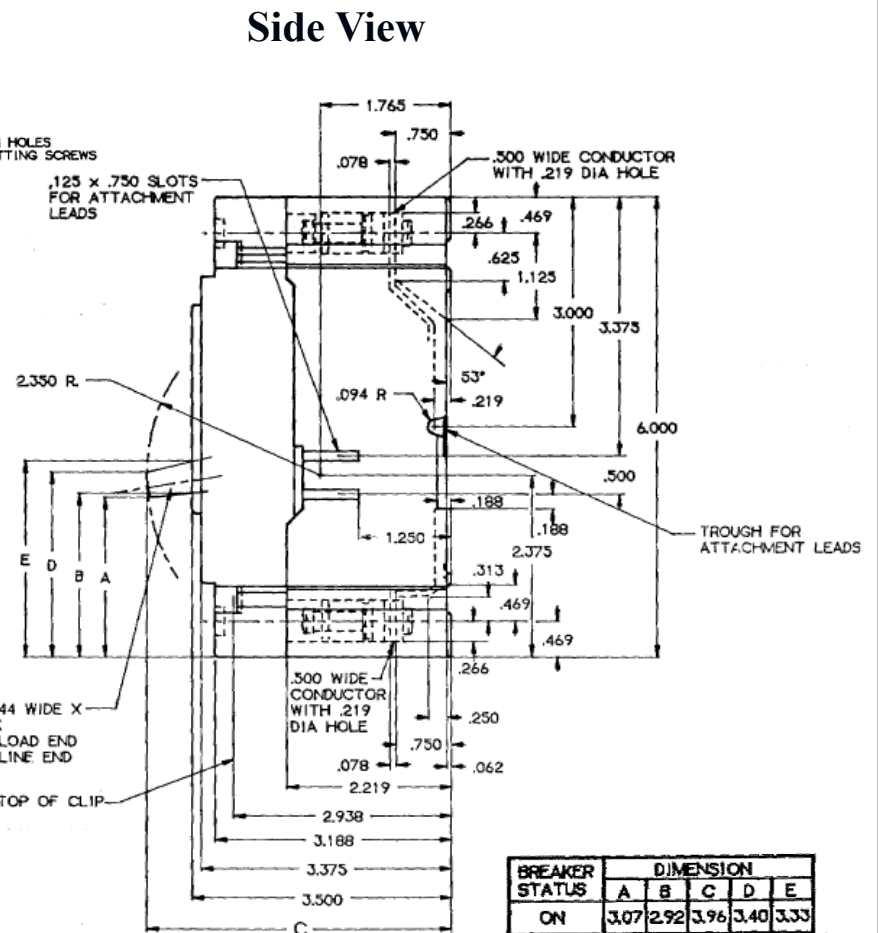

BREAKER STATUS	DIMENSION				
	A	B	C	D	E
ON	3.07	2.92	3.96	3.40	3.33
TRIPPED	2.63	2.57	4.06	2.99	2.98
OFF	2.06	2.14	4.12	2.42	2.56
RESET	1.98	2.03	4.11	2.30	2.48

Breaker Amps	Load Side Wire Range Size
125A	(1) #4 - 4/0 (AL/CU)

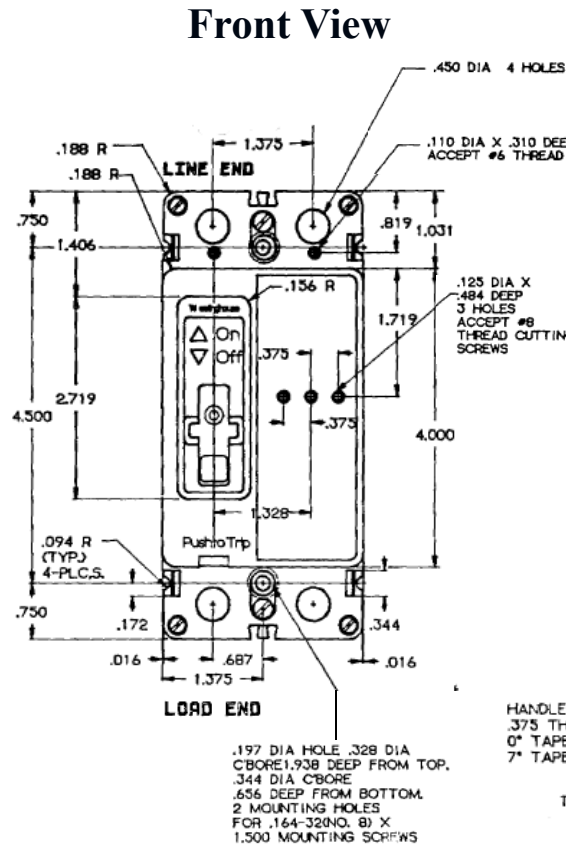
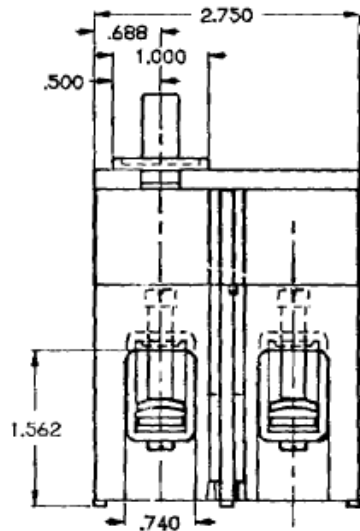

Bottom View

MM suffix provides mounting hardware for Residential Meter stacks. Hardware comes in separate bag in the field



imagination at work

125A 2P TMQV BREAKER 100K @ 120/240V
FOR USE WITH GE METER STACKS -200A & 225A SOCKETS

REF NO	CAT NO	DWG DATE	REV #
1490D62	TMQV22125MM	11/05/2015	01