

Top View

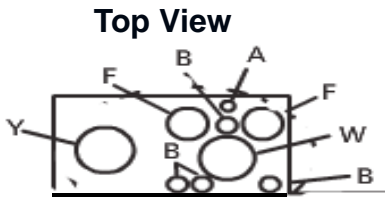

Hub Dimensions

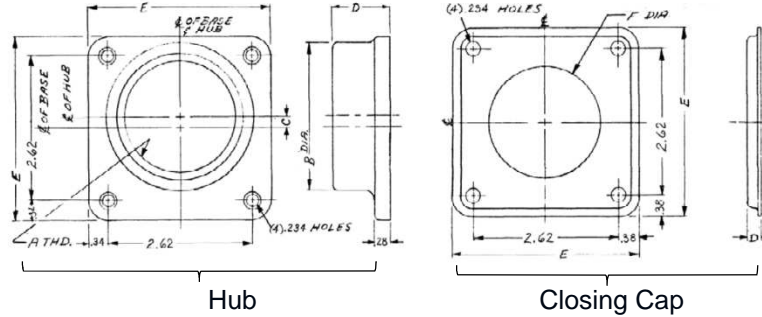

Available Hubs

Cat#	Mod#	A-THD	B-DIA	C	D	E
TC75	2	"3/4-14"	1.31	0.81	1.03	3.31
TC100	2	"1 - 11 1/2"	1.53	0.69	1.03	3.31
TC125	2	"1 1/4 - 11 1/2"	1.88	0.53	1.03	3.31
TC150	2	"1 1/2 - 11 1/2"	2.12	0.42	1.03	3.31
TC200	2	"2 - 11 1/2"	2.62	0.2	1.03	3.31
TC250	2	"2 1/2 - 8"	3.19	NONE	1.22	3.31
TCCP Closing Cap	1	NONE	NONE	NONE	0.25	3.38

Front Layout View

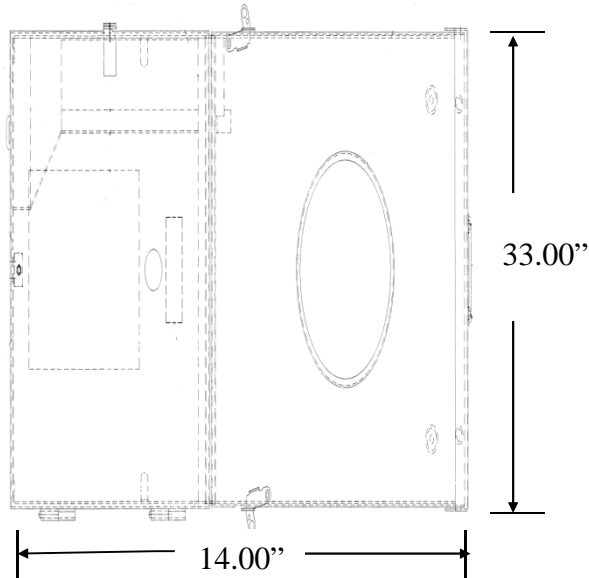

Front Interior View

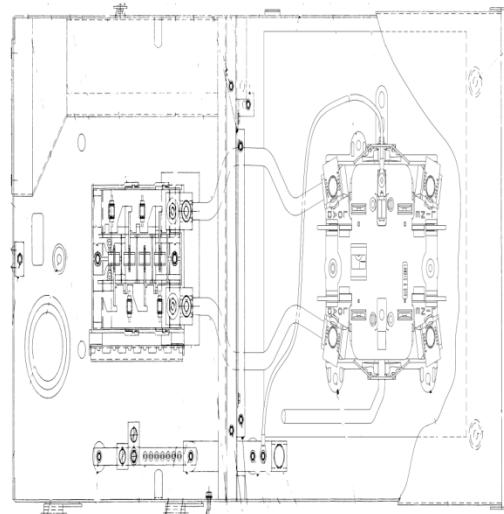

Side View

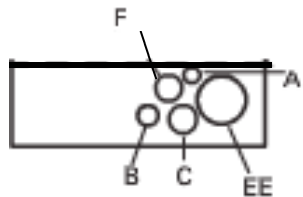
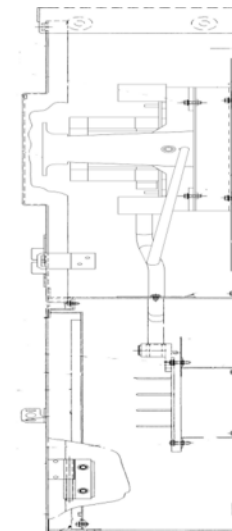

Bottom View

Main Wire Size
#1 - 350MCM (Al/Cu)

Symbol	A	B	C	D	E	F	G	H	J	K	L	M	N	P	Q	R	S	T	U	V	W	X	Y	Z	AA	BB	CC	DD	EE	FF	
Conduit Size in inches	5/32	-	-	-	-	-	-	-	-	-	-	-	-	-	-	-	-	-	-	-	-	-	-	-	-	-	-	-	-	-	
	3/8	-	-	3/8	-	3/8	-	-	-	-	-	-	-	-	-	-	-	-	-	-	-	-	-	-	-	-	-	-	-	-	
	1/2	1/2	1/2	1/2	-	1/2	1/2	1/2	-	-	-	-	-	-	-	1/2	-	-	-	-	-	-	-	-	1/2	1/2	1/2	1/2	-	-	
	-	-	3/4	3/4	3/4	3/4	3/4	3/4	3/4	-	-	-	3/4	-	3/4	-	-	-	-	-	3/4	-	3/4	-	3/4	3/4	-	3/4	-	-	
	-	-	-	-	-	1	1	1	1	1	1	1	1	1	1	1	-	-	1	-	1	-	1	-	1	1	1	1	1	1	1
	-	-	-	-	-	1 1/4	-	1 1/4	1 1/4	1 1/4	1 1/4	1 1/4	1 1/4	1 1/4	1 1/4	1 1/4	-	1 1/4	1 1/4	-	1 1/4	1 1/4	-	1 1/4	1 1/4	-	1 1/4	1 1/4	1 1/4	1 1/4	
	-	-	-	-	-	1 1/2	-	-	-	-	-	1 1/2	1 1/2	1 1/2	1 1/2	-	1 1/2	1 1/2	-	1 1/2	1 1/2	-	1 1/2	1 1/2	-	1 1/2	1 1/2	1 1/2	1 1/2	1 1/2	
	-	-	-	-	-	-	-	-	-	-	-	-	-	2	2	2	2	2	2	2	2	2	2	2	2	2	2	2	2	2	2
	-	-	-	-	-	-	-	-	-	-	-	-	-	-	2 1/2	2 1/2	2 1/2	2 1/2	-	2 1/2	2 1/2	-	2 1/2	2 1/2	-	2 1/2	2 1/2	2 1/2	2 1/2	2 1/2	
	-	-	-	-	-	-	-	-	-	-	-	-	-	-	-	-	-	-	-	3	3	-	3	-	3	3	-	3	3	3	
	-	-	-	-	-	-	-	-	-	-	-	-	-	-	-	-	-	-	-	3 1/2	3 1/2	3 1/2	-	3 1/2	3 1/2	-	3 1/2	3 1/2	3 1/2	3 1/2	
	-	-	-	-	-	-	-	-	-	-	-	-	-	-	-	-	-	-	-	-	4	-	-	-	4	-	-	-	-	-	

 **imagination at work**

Main Lug Only - Ringless - 200A 22K - 4/8 Circuits - N3R Encl - Surface Front - OH/UG Incoming Feed - Lever Bypass - Xcel Colorado

CAT NO	DWG DATE	REV #
TSLB420CSCU	6/4/2015	01