

### Top View

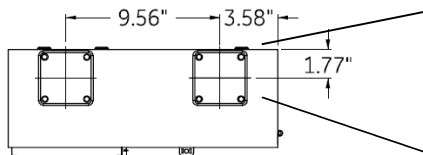

### Hub Dimensions

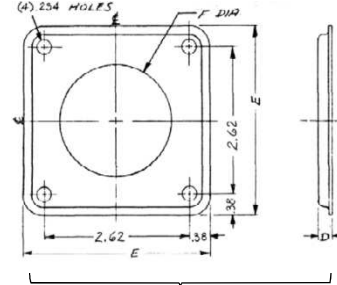
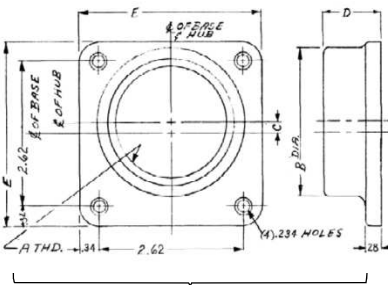

### Available Hubs

Cat#	Mod#	A-THD	B-DIA	C	D	E
TC75	2	"¾-14"	1.31	0.81	1.03	3.31
TC100	2	"1 - 11 ½"	1.53	0.69	1.03	3.31
TC125	2	"1 ¼ - 11 ½"	1.88	0.53	1.03	3.31
TC150	2	"1 ½ - 11 ½"	2.12	0.42	1.03	3.31
TC200	2	"2 - 11 ½"	2.62	0.2	1.03	3.31
TC250	2	"2 ½ - 8"	3.19	NONE	1.22	3.31
TCCP Closing Cap	1	NONE	NONE	NONE	0.25	3.38

### Front View

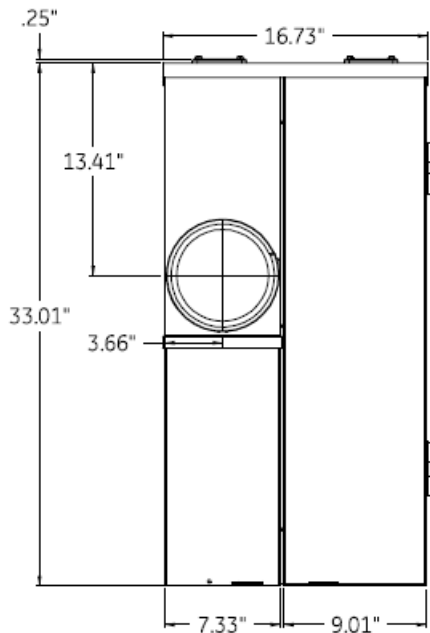

### Side View

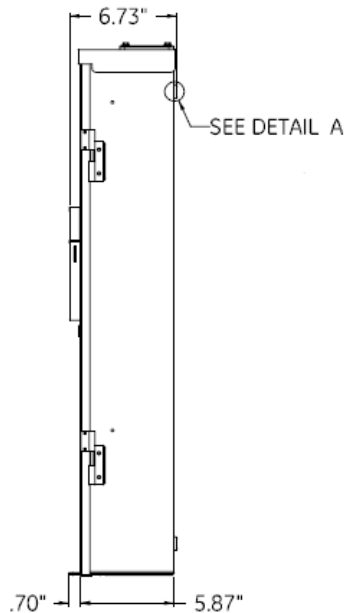

### Closing Cap

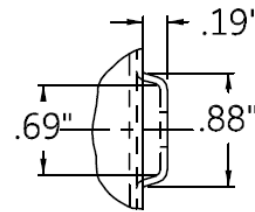

### Detail A

**Main Wire Size**  
 # 1 – 300MCM CU  
 2/0 – 250MCM AL

### Back View

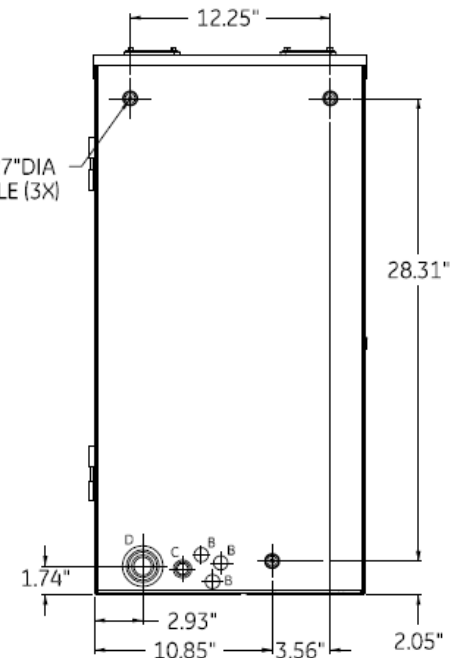

### Bottom View

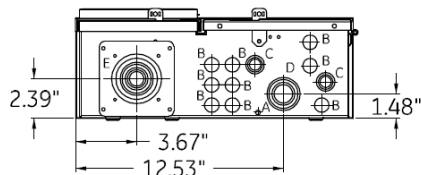

All DIMENSIONS HAVE +/- .125 TOLERANCE

SYMBOL	SIZE	QTY.
A	9/32 KO	1
B	1/2 KO	12
C	3/8 X 1/2 X 3/4 KO	3
D	3/4 X 1 X 1 1/4 X 1 1/2 KO	2
E	1/2 X 3/4 X 1 X 1 1/4 X 1 1/2 X 2 X 2 1/2 KO	1



imagination at work

Main Breaker THQMV - Ring - 150A 22K - 8/16 Circuits - N3R  
 Encl - Surface Front - UG/OH Incoming Feed - EUSERC Listed

CAT NO	DWG DATE	REV #
TSM815CSCU	6/4/2015	01