

Top View

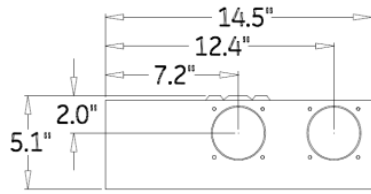

Hub Dimensions

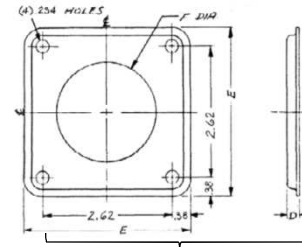
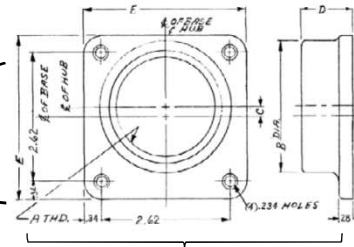

Available Hubs

Cat#	Mod#	A-THD	B-DIA	C	D	E
TC75	2	"3/4 - 14"	1.31	0.81	1.03	3.31
TC100	2	"1 - 11 1/2"	1.53	0.69	1.03	3.31
TC125	2	"1 1/4 - 11 1/2"	1.88	0.53	1.03	3.31
TC150	2	"1 1/2 - 11 1/2"	2.12	0.42	1.03	3.31
TC200	2	"2 - 11 1/2"	2.62	0.2	1.03	3.31
TC250	2	"2 1/2 - 8"	3.19	NONE	1.22	3.31
TCCP Closing Cap	1	NONE	NONE	NONE	0.25	3.38

Front View

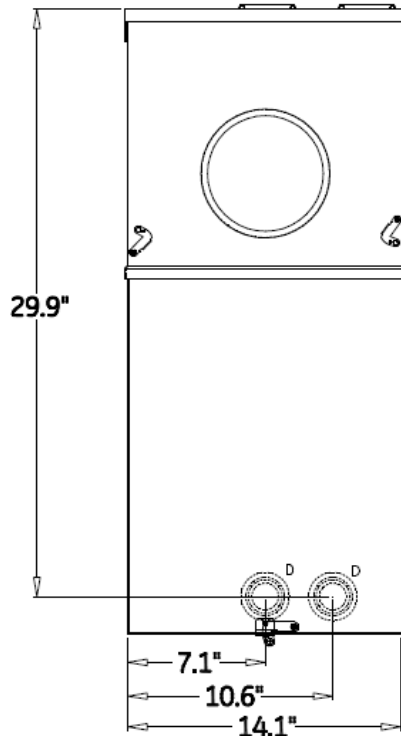

Front Layout View

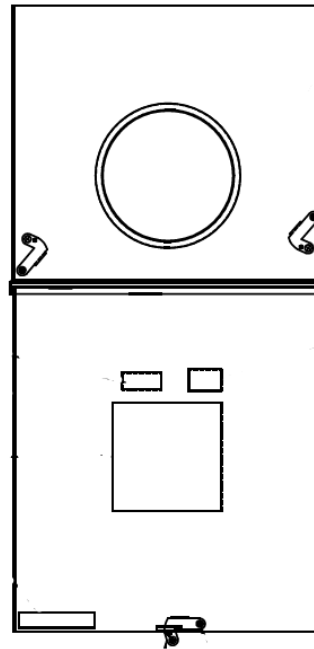

Side View

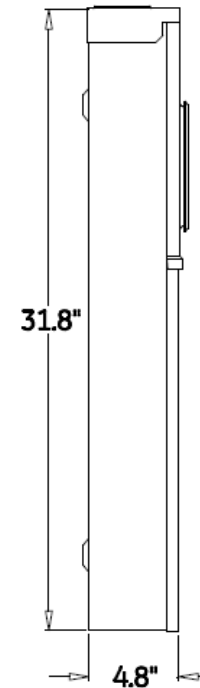

Main Wire Size

6 - 4/0 (AL/CU)

Bottom View

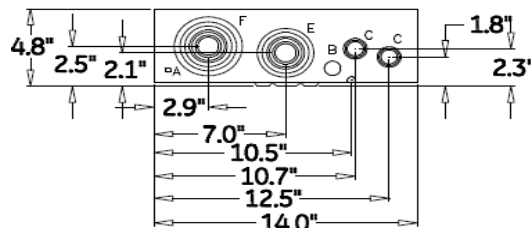

ALL DIMENSIONS HAVE +/- .125 TOLERANCE

SYMBOL	SIZE	QTY.
A	9/32 KO	1
B	3/4 KO	1
C	1/2 X 3/4 X 1 KO	2
D	1/2 X 3/4 X 1 X 1 - 1/4 X 1 - 1/2 X 2 KO	3
E	1/2 X 3/4 X 1 X 1 - 1/4 X 1 - 1/2 X 2 X 2 - 1/2 KO	1
F	1-1/4 X 1-1/2 X 2 X 2-1/2 X 3 KO	1



imagination at work

Main Breaker THQMV - Ring - 150A 22K - 4/8 Circuits - N3R Encl
Surface Front - UG/OH Incoming Feed - Farm - Feed-Thru Lugs

CAT NO

DWG DATE

REV #

TSMF415CSFL

09/16/2015

01