

Top View

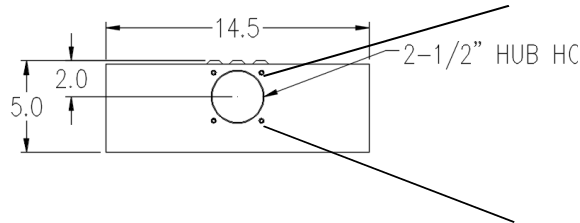

Hub Dimensions

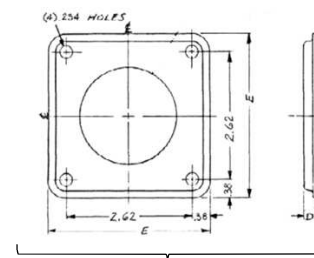
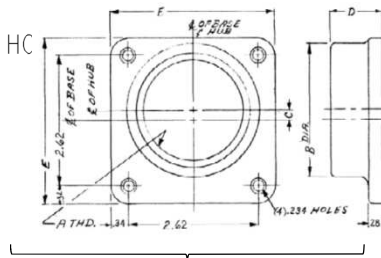

Available Hubs

Cat#	Mod#	A-THD	B-DIA	C	D	E
TC75	2	"3/4-14"	1.31	0.81	1.03	3.31
TC100	2	"1 - 11 1/2"	1.53	0.69	1.03	3.31
TC125	2	"1 1/4 - 11 1/2"	1.88	0.53	1.03	3.31
TC150	2	"1 1/2" - 11 1/2"	2.12	0.42	1.03	3.31
TC200	2	"2 - 11 1/2"	2.62	0.2	1.03	3.31
TC250	2	"2 1/2 - 8"	3.19	NONE	1.22	3.31
TCCP Closing Cap	1	NONE	NONE	NONE	0.25	3.38

Front Separated View

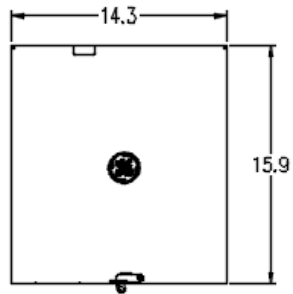
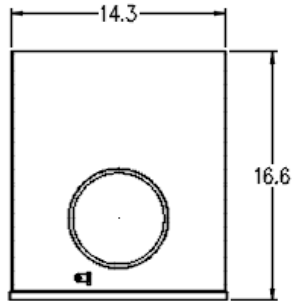

Hub Side View

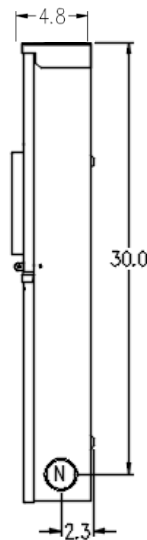

Closing Cap

Inside View

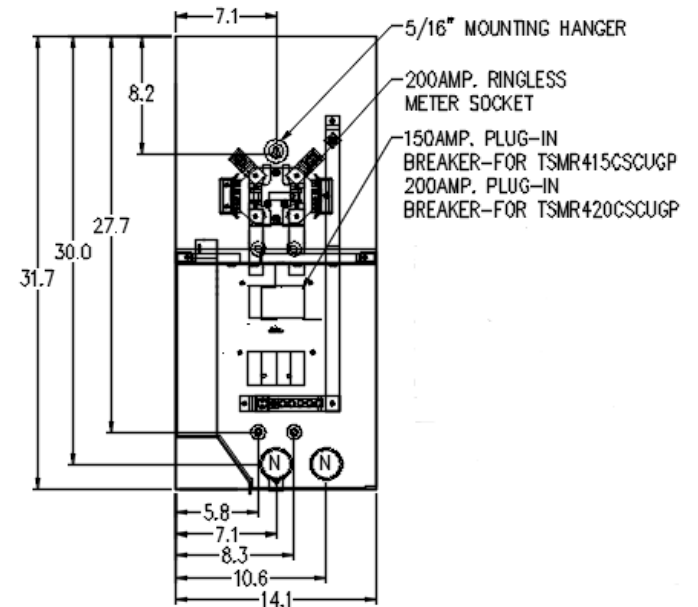

Wire Sizes

CONNECTOR	COPPER		ALUMINUM	
	SOLID	STRAND	SOLID	STRAND
LINE METER SOCKET	-----	6-350	-----	6-350
LOAD BASE	-----	1-300	-----	2/0-300
NEUTRAL A	-----	6-350	-----	6-350
NEUTRAL/GRND. B	-----	14-2/0	-----	14-2/0
NEUTRAL/GRND. C	14-8	14-4	12-8	12-4
NEUTRAL/GRND. D	-----	1-300	-----	1-300

Bottom View

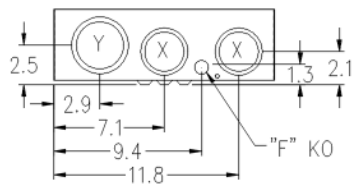

Knockouts

N= 1/2", 3/4", 1", 1-1/4", 1-1/2", 2" KO
 X= 1/2", 3/4", 1", 1-1/4", 1-1/2", 2", 2-1/2" KO
 F= 1/2" KO
 Y= 1-1/4", 1-1/2", 2", 2-1/2", 3" KO



imagination at work

Main Breaker THQMV - Ringless - 200A 22K- 4/8 Circuits - N3R Encl Surface Front - UG/OH Incoming Feed - Feed-Thru Lugs - GP Listed

CAT NO	DWG DATE	REV #
TSMR420CSCUGP	6/4/2015	01