

Top View

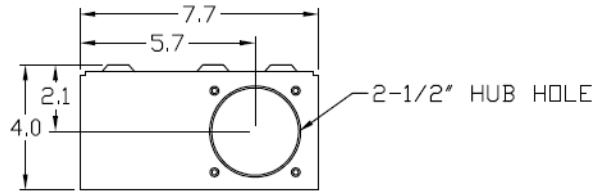

Knockouts

F= 1/2" KO
G= 1/2", 3/4", 1" KO
V= 3/4", 1", 1-1/4", 1-1/2" KO

Left Side View

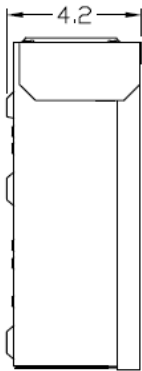

Front View Interior

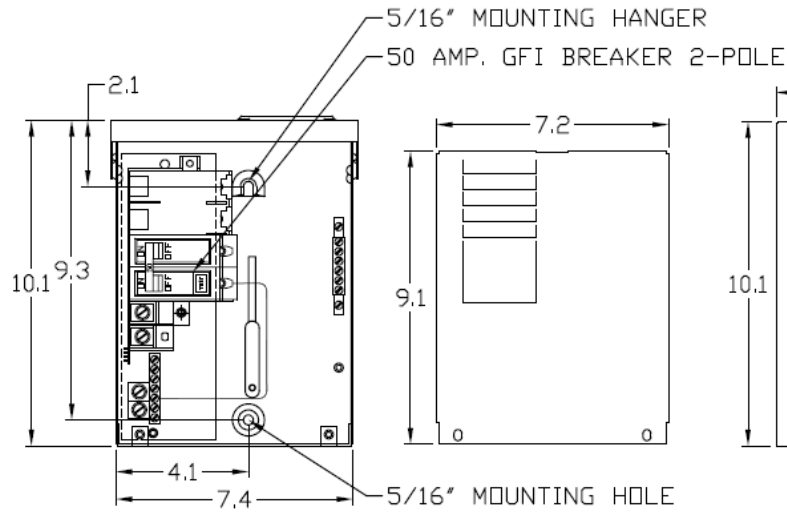

Front View Inside Cover

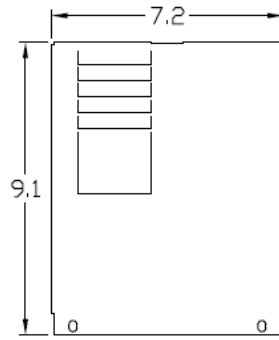

Front View External Covers

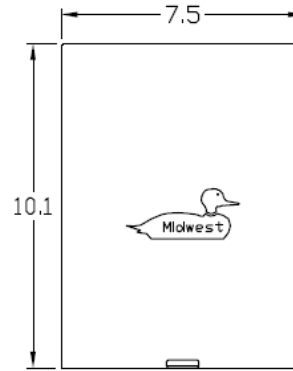

Right Side View

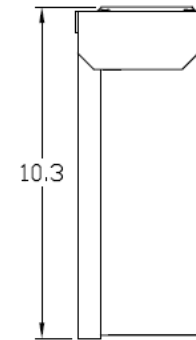

Configuration

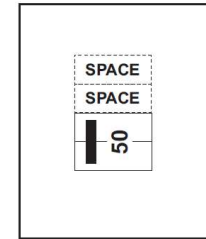

Bottom View

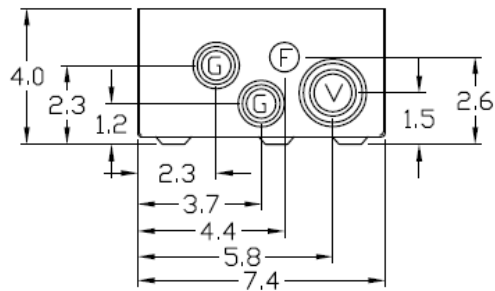

Wire Range Size

#6-2/0 AWG CU-AL



MIDWEST SPA PANEL 125A W/ 50A GFCI DISCONNECT N3R 1PH3W 120/240V 2/4 CKT UL LISTED TOP/BOTTOM G90 STEEL

CAT NO	DWG DATE	REV #
UG412RMW250	03/22/2016	02