

REVISIONS				
REV.	ECN	DESCRIPTION	DATE	APPROVED
B	-	MODIFIED	03-11-2009	T.G.A. KP

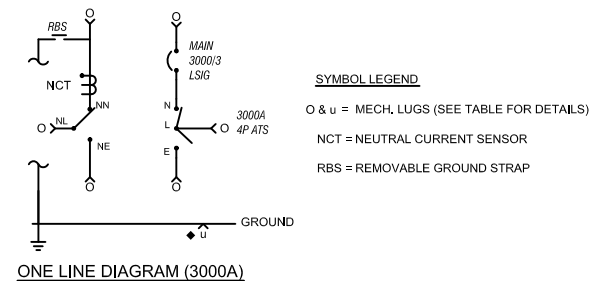

NOTES:			
SYSTEM RATING: 100KA			
ENCLOSURE:	NEMA 3R TYPE	LABELS	
INSTALLATION:	FLOOR MOUNTED	1. Y320082	UL891 (ON INNER SIDE OF DOOR)
FINISH:	ANSI 61 GRAY	2. V-1811	SUITABLE FOR AS SERVICE ENTRANCE
ACCESS:	REAR & SIDES	3. YA32699	SERVICE DISCONNECT
COMPONENTS RATING AND SPECIFICATIONS (ATS):		4. YA90026	UL COMPLIANCE SHEET
SERVICE ENTRANCE:	2600-3000A, 4 POLE UNIT, FULLY RATED	5. YA31193	SECTION AMPACITY
SHORT CIRCUIT WITHSTAND AND CLOSING RATING (CUL)	100kA @ 480V	6. YA30600	500-1000 MCM TORQUE
CIRCUIT BREAKER:		7. YA30601	NEMA 3R ENCLOSURE
GE PB11-ICCB, MICRO-VERSA TRIP PLUS, LSIG TRIP UNIT		8. YA30602	NEUTRAL TO GROUND LINK
		9. YA31238	HIGH VOLTAGE DANGER
MOUNT TYPE:	STATIONARY		
SIZE:	3000AF/3000AT-2500AT		
SHORT CIRCUIT INTERRUPT RATING	100kAIC @ 480V		
UL LABEL:	B91		
	SUITABLE TO USE AS SERVICE ENTRANCE EQUIPMENT		
BUS:			
MATERIAL:	COPPER 1000A/in C3-1/4\" X 5\" PHASE/NEUTRAL		
	C1-1/4\" X 3\" GROUND BUS		
FINISH:	SILVER PLATED		
CABLE:			
S2-N	(3)-600kcmil PER PHASE & NEUTRAL		
LOAD	(3)-600kcmil PER PHASE & NEUTRAL		
EMERGENCY	(3)-600kcmil PER PHASE & NEUTRAL		
GROUND	(24)-1/0-250kcmil		

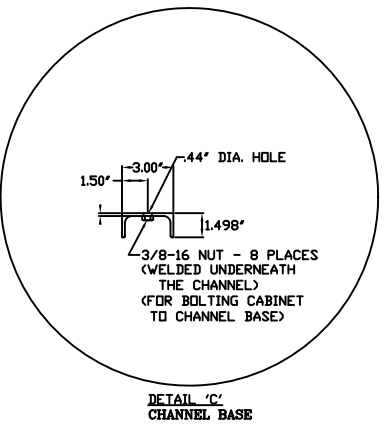
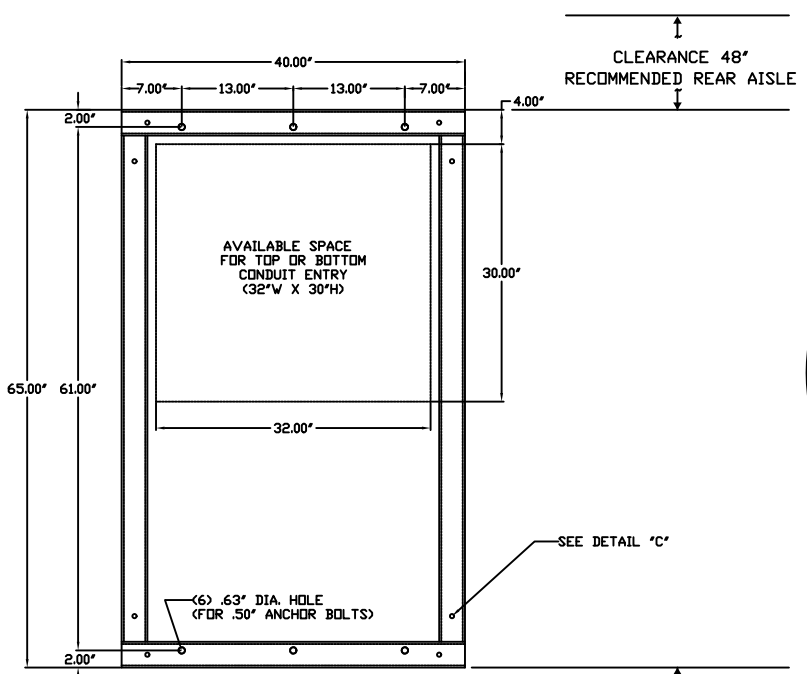
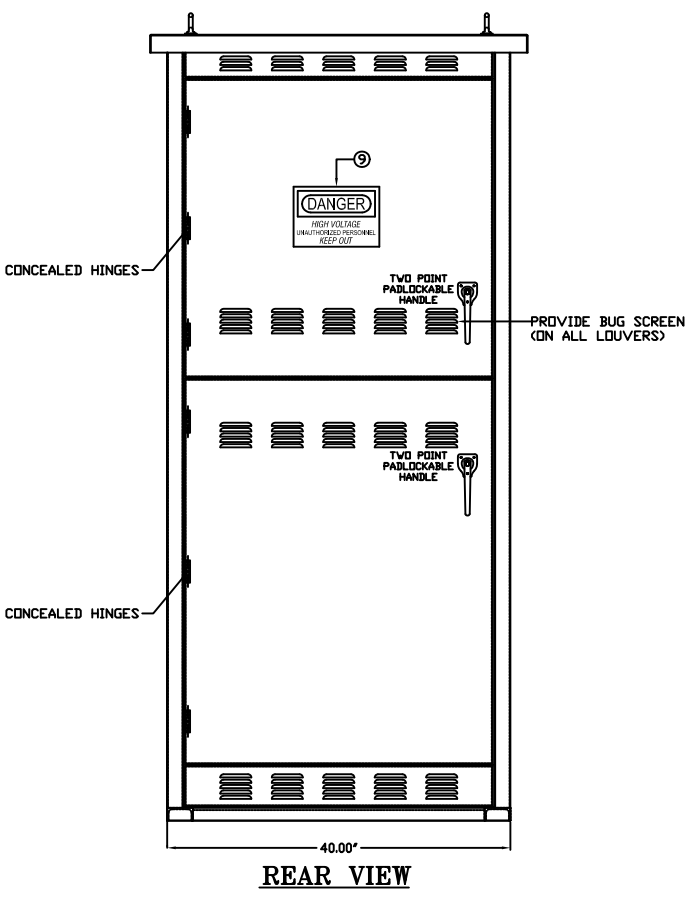
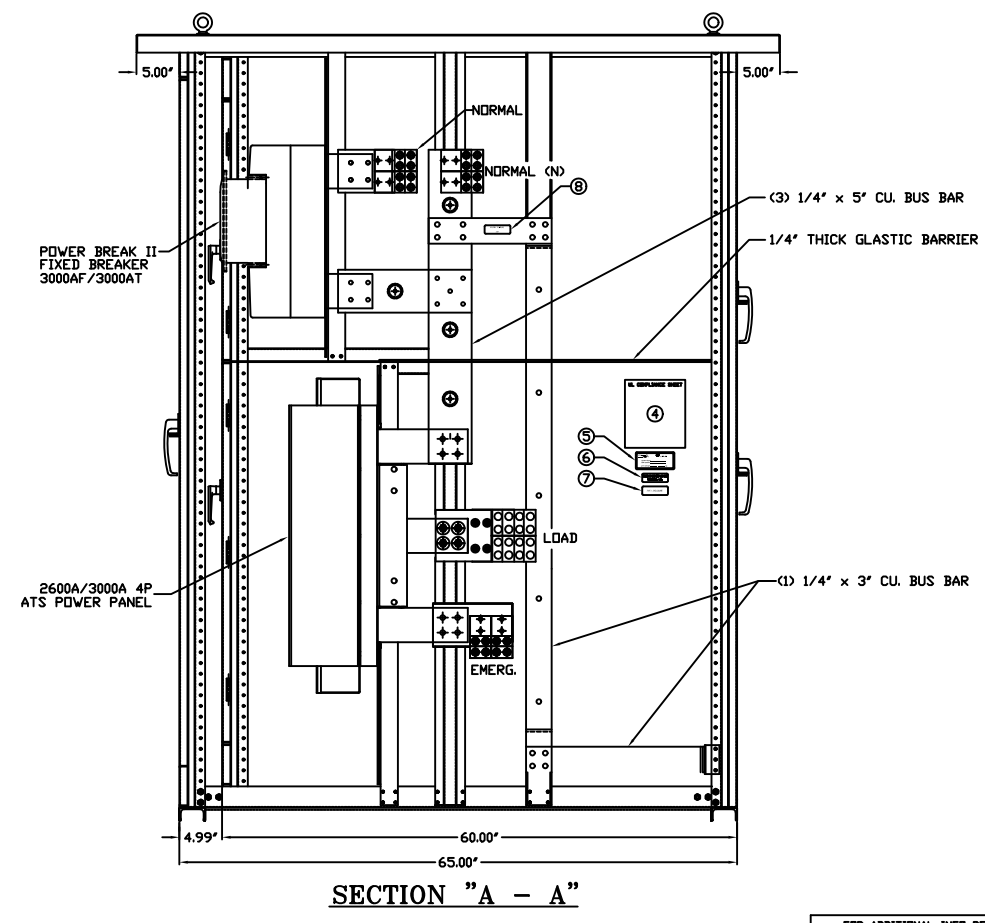
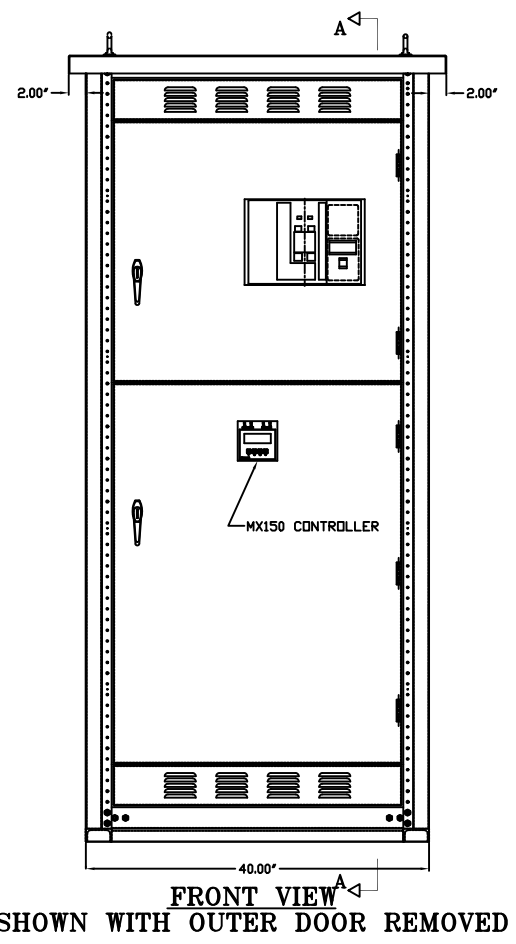
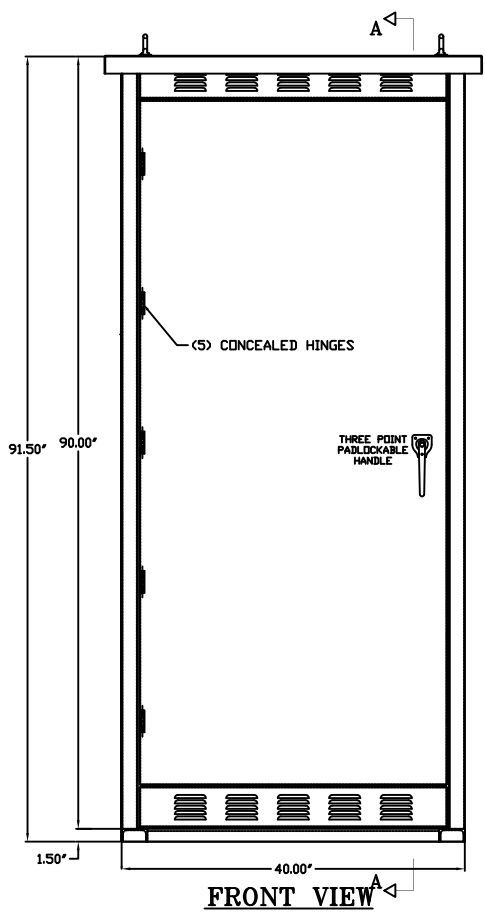

NEMA_3R_ENCLOSURE
4_POLES_ATS

NOT CERTIFIED
FOR CONSTRUCTION

GE PROPRIETARY AND CONFIDENTIAL INFORMATION
This document is the property of General Electric Company (GE) and contains proprietary information of GE. This document is loaned on the express condition that neither it nor the information contained therein shall be disclosed to others without the express written consent of GE Industrial Systems, and that the information shall be used by the recipient only as approved expressly by GE Industrial Systems. This document shall be returned to GE upon its request. This document may be subject to certain restrictions under U.S. export control laws and regulations.

FOR ADDITIONAL INFO REFER TO	SIGNATURES	DATE
APPLIED PRACTICES	MODEL T.G.A.	10-25-2007
UNLESS OTHERWISE SPECIFIED DIMENSIONS ARE IN INCHES	DETAIL	
TOLERANCES ON:	CHECKED	
2 PL. DECIMALS ± .020	ENGRG T.G.A.	
3 PL. DECIMALS ± .005	MFG	
ANGLES ± 1°	QUALITY	
FRACTIONS ± 1/64	ISSUED	
FINISH ✓	DRAWING FILE: ZTGSE30(4P-N3R)-OUT	SHEET 1
	MODEL / ASSEMBLY FILE:	CAGE CODE N/A
	# CTQs	DWG NO. ZTGSE30(4P-N3R)-OUT
	CRITICAL TO QUALITY CHARACTERISTIC	SCALE: NONE

GE Zenith Controls

TITLE: 2500-3000A SERVICE ENTRANCE (4P-N3R)
ZTGSE OUTLINE DRAWING

FIRST MADE FOR: ZTGSE30(4P-N3R)-OUT

SHEET 1 OF 1

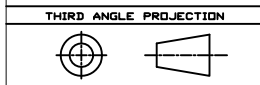

AutoCad Generated